



CREILLE

[Dérivé du mot Treille]
Colonne lumineuse ajourée
au profil concave spécifique.

[Derived from the
French word «Treille»]
Openwork lighting column with
specific concave profile.

← **Anglet, Quartier Larochefoucault (FR)**
Maîtrise d'ouvrage / Contracting authority:
Communauté d'agglomération du Pays Basque,
Ville d'Anglet, Eiffage Immobilier
Paysagiste / Landscape architect:
Woodstock Paysage
Concepteur lumière / Lighting designer:
Quartiers Lumières

CREILLE / CREILLE GM Borne / Bollard

Construction en aluminium / Intégralement sans soudure
Aluminum made / Entirely weld-free

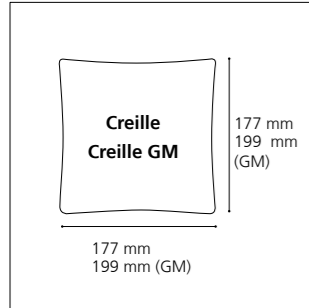

Corps

- Hauteurs de 1 à 1,4 m
- Profil aluminium exclusif avec structure interne fonctionnelle, ajouré sur les 4 faces
- Creille : porte d'accès pivotante (sans motif)
- Creille GM : porte d'accès intégrant le motif (option)

Body

- Heights from 1 to 1.4 m
- Exclusive aluminum profile with internal structure, fretted on the 4 sides
- Creille : pivoting access door (without pattern)
- Creille GM : access door with pattern (optional)

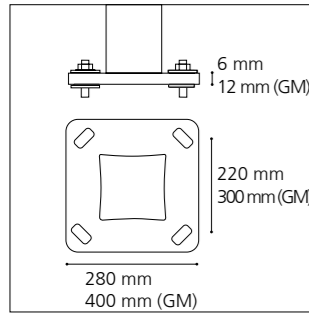

Semelle

- Extra plate, en aluminium
- Bagues isolantes au droit des 4 trous d'ancrage pour éviter tout contact avec les tiges en acier galvanisé

Baseplate

- Extra-flat, made of aluminum
- Insulating rings on the 4 anchoring holes to avoid any contact with galvanized steel bolts



Luminaire LED interne Karéo²™

- 16W, 33W
- 2200, 2700, 3000, 4000 ° K
- 2385-4480 lm
- Pilotage DALI, 0-10 V sur demande

Karéo²™ internal LED fixture

- 16W, 33W
- 2200, 2700, 3000, 4000 ° K
- 2385-4480 lm
- Pilotage DALI, 0-10 V on demand

Royal Golf Marrakech (MA)

Maitrise d'ouvrage / Contracting authority: Royal Golf de Marrakech
Architecte / Architect: Primarios
Paysagiste / Landscape architect: Atelier KLP
Concepteur lumière / Lighting design: Agence ON

© Royal Golf de Marrakech

+ Finition

- Thermolaquage par poudre
Polyester, coloris RAL ou finitions spéciales
- Anodisation (20 microns)

Finish

- Polyester powder coating,
RAL colors or special finish
- Natural anodization (20 microns)

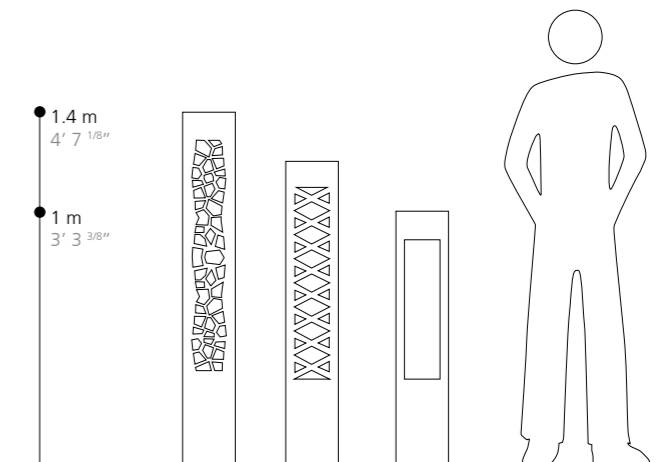

CREILLE

Collection de motifs Technilum®
Technilum®'s patterns collection

Géométrique / Geometric

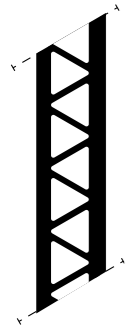

Triangle
Triangolo



Losange
Diamond



Art Deco II
Art Deco II

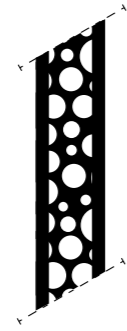

Bulle
Bubble

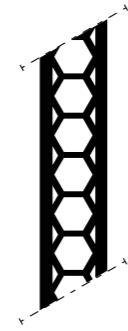

Nid d'abeille
Honeycomb

Organique / Organic

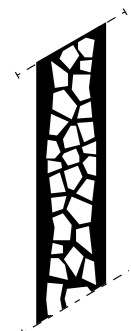

Girafe
Giraffe

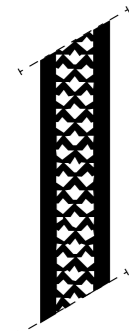

Palmier
Palm tree



Jungle
Jungle

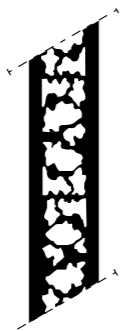

Feuillage
Foliage



Vagues
Waves

Décoratif / Decorative



Art Nouveau
Art Nouveau



Arabesque
Arabesque

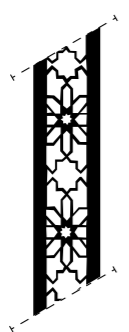

Moucharabieh II
Wooden lattice II

...

→ **Belgrade, Waterfront (RS)**
Maîtrise d'ouvrage / Contracting authority:
Eagle Hills, Government of Serbia
Architecte / Architect: RTKL
Paysagiste / Landscape architect: SWA
Concepteur lumière / Lighting design: Buro
Happold London

© Starcevic Branko

Ces motifs sont extraits de notre collection permanente. Ils vous sont présentés à titre indicatif. Il est bien sûr également possible de laisser libre cours à votre imagination et de créer les découpes sur-mesure* spécifiques pour votre projet !

* Sous réserve de validation technique par notre bureau d'études.

These patterns are taken from our permanent collection. They are presented to you as an indication only. Of course, it is also possible to let your imagination run wild and create custom cuts* specifically for your project !

* Subject to technical validation by our design office.



KARÉO²™

Luminaire LED intégrable
Integrable LED luminaire

Compatible avec / with :

Treille, Creille, Creille GM, Creille qui Pousse, Borne Creille, Borne Treille, Borne Shiraz (K), Tannat, Zinfandel...

Hauteur max. préconisée / Max. height recommended : 6 m seul (1 unit), 9 m combiné (2-3 units)

Description

- Corps en aluminium
- Dimensions : 90 x 90 x 60 mm
- Dissipateur thermique et driver LED intégrés
- Éclairage par 16 LEDs - Avec optiques silicines
- Prisme optique réfractant la lumière
- Certifications : CE, CSA/UL
- Garantie 2 ans

Description

- Body made of die-cast aluminium
- Dimensions: 90 x 90 x 60 mm
- Integrated LED driver and heat sink
- LED luminaire, 16 LEDs lighting
- Optical prism reflecting light
- Certifications: CE, CSA/UL
- 2 year guarantee

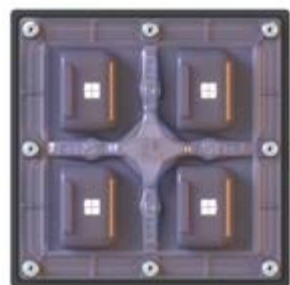

Informations techniques / Technical specifications

Indice de protection / Protection	IP 66 / IK 08	
Classe / Class	I (II possible)	
Puissance / Power	16 W	33 W
Flux sortant / Outflow (3000°K)	2385 lm	4480 lm
T° de couleur / Color t°	2200, 2700, 3000, 4000 °K	
IRC / CRI	>70	
Durée de vie / Lifespan (L80B10)	> 108 000	
Driver	Pilotage DALI, 0-10 V (sur demande / upon request)	

Photométries / Photometry

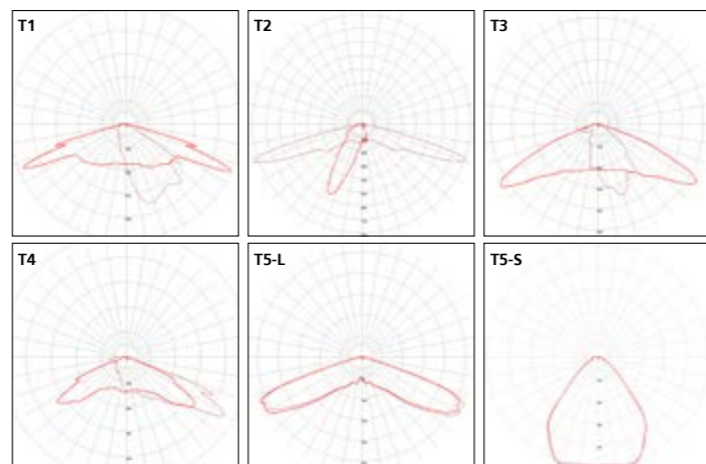

● REF.WEB → REF006

